



**HIGH PERFORMANCE** 



**PZ CARBURETOR  
PERFORMANCE TUNING  
AND MAINTENANCE**





# PZ CARBURETOR PERFORMANCE TUNING AND MAINTENANCE

All information provided is intended for general guidelines and practices for Basic Operation, Tuning, and Maintenance of Walbro PZ Slide Valve Carburetors.

## Contents:

SAFETY	2
TUNING	3
Idle and Low Speed	4
Midrange/Part Throttle	5
High Speed/Full Throttle	5
TUNING TIPS	6
SET-UP	6
MAINTENANCE	7
SPECIFICATIONS	7
NOTES	8
EXPLODED VIEWS	8

### SAFETY

**As with any carburetor or fuel system, care must be taken to avoid fire from leaking or spilled fuel.** Be sure all gaskets and seals are in good condition and properly assembled. Dispose of any drained or spilled fuel. Check condition of fuel lines and connections before every use. Fuel must be drained from the system if vehicle or engine is not stored or transported in a level position.

**It is necessary to check the carburetor slide for free movement through the full range of travel any time the carburetor has been removed, installed, or adjusted and before starting the engine.** Remove air filter and visually confirm the slide valve is fully closed as the throttle is released. Work the throttle control from closed to fully open and watch for any sticking or hang-up. Engines could start with an open throttle resulting in a runaway vehicle. Always install the correct return spring for the carburetor and use an additional return spring on the throttle pedal as needed.

**Motorsports are dangerous and can lead to injury or death.**

## TUNING

**Rich and Lean:** An internal combustion engine needs a specific ratio or mixture of air and fuel for best performance. This mixture is delivered by the carburetor. In the following discussion numerous references will be made to the air and fuel mixture (air/fuel ratio) being rich or lean. Rich refers to a mixture with an excess of fuel. Lean refers to a mixture with an excess of air.

### Float height

Parts involved:

- Float
- Inlet Needle

The float height controls the fuel level in the float bowl. This adjustment determines the point at which the inlet needle opens as the fuel level drops in the bowl. Float height is usually measured with the float bowl removed and is specified from the carburetor body to an edge or surface on the float. The float should be resting on the inlet needle but not depressing the spring under the needle stem when this measurement is taken. To adjust, carefully bend the tab where it makes contact with the inlet needle.

The float height should be adjusted before any other adjustments are made. A higher fuel level will cause a richer mixture and possibly excess overflow from the vents. A lower fuel level will cause a leaner mixture and could lead to an engine miss or cut-out while cornering. Start at the specified height and change as needed for best performance on different type of tracks.

The float drop should also be checked. The proper adjustment will prevent the needle from pulling too far out of the inlet seat and becoming stuck in the open position.

PZ22



PZ26



## Idle and Low Speed

Parts involved:

- Idle Speed Screw
- Idle Mixture Screw
- Pilot Jet (Idle Jet, Slow Jet)

Carburetor tuning at idle and low speed is accomplished by adjusting the Idle Mixture Screw, the Pilot (or Idle) Jet, and Idle Speed Screw. These adjustments will control idle speed, idle quality, and initial responsiveness/acceleration of the engine.

The screw in the center of the side of the carburetor body is the Idle Speed adjustment. This screw holds the throttle slide valve open slightly to obtain the desired engine rpm at closed throttle. Turning the idle speed screw clockwise will increase rpm. Turning counter-clockwise will decrease rpm.

The Pilot Jet is screwed into the carburetor body and is located inside the float bowl. (See photo, next page.) The Pilot Jet meters the amount of fuel entering the low speed circuit. A larger or smaller jet will change fuel flow accordingly. The size of the jet in millimeters is stamped on it.

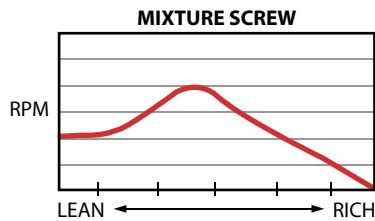

The Idle Mixture Screw can be either an air or fuel adjustment so it should be determined what type of change you are making. A mixture screw on the air filter side of the PZ22 carburetor is an air-only adjustment so opening the screw (turning counterclockwise) will increase the air bleed and lean the mixture. The mixture screw on the engine side of the PZ26 carburetor is a fuel adjustment. Opening the screw will allow more fuel into the engine for a richer mixture.

For an initial setting, gently turn the mixture screw in until it lightly seats or

stops. Back out the specified number of turns. The optimum setting of the mixture screw will usually result in the highest rpm with the throttle closed. As the amount of fuel is varied the engine rpm will also vary. With throttle closed and engine warm and running at or slightly above desired idle speed, slowly turn the Idle Mixture Screw in or out to obtain the highest rpm. Then set the idle speed screw to obtain the desired rpm.

If a smooth idle cannot be set with the idle mixture screw between ¼ to 2-¼ turns out, or if the engine does not respond to adjustment, a different size Pilot Jet may be needed. The pilot jet, also called idle or slow jet, controls the amount of fuel at idle and throttle positions up to ¼ open. If the mixture needle cannot be leaned out enough, a smaller Pilot Jet should be installed. A larger jet should be installed if the mixture is too lean. The proper Pilot Jet size will allow a satisfactory setting with the mixture screw.

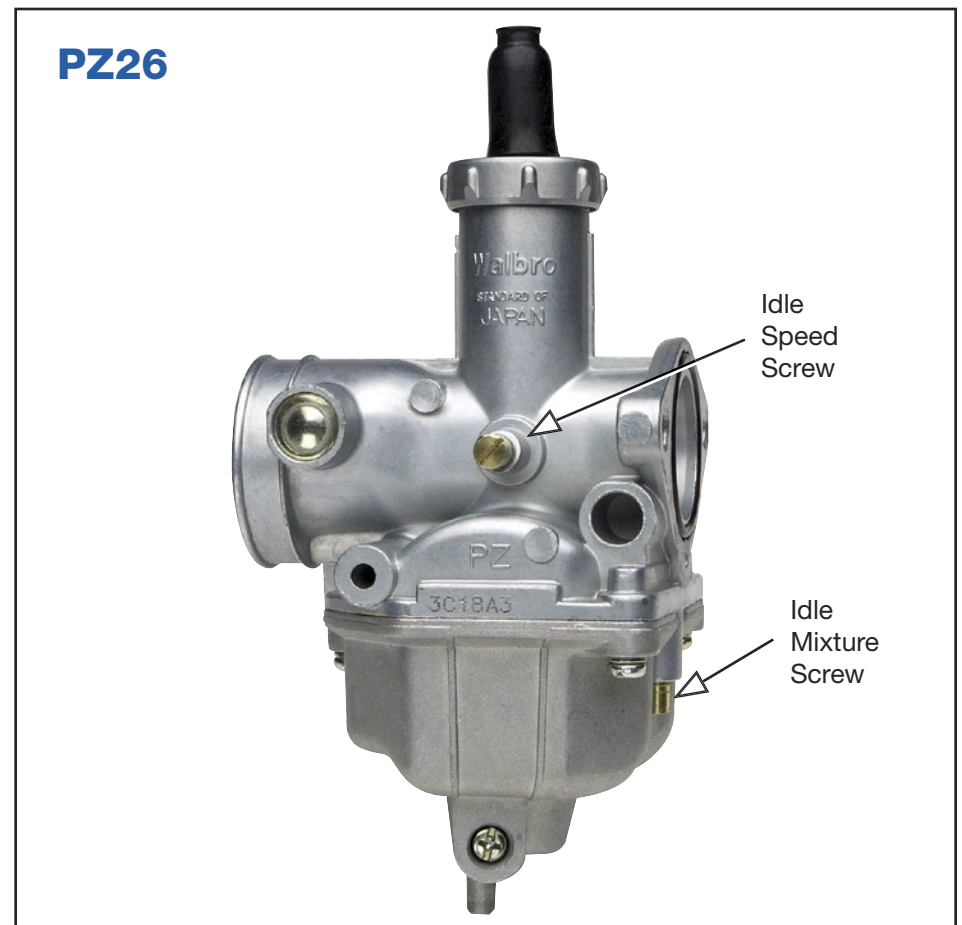
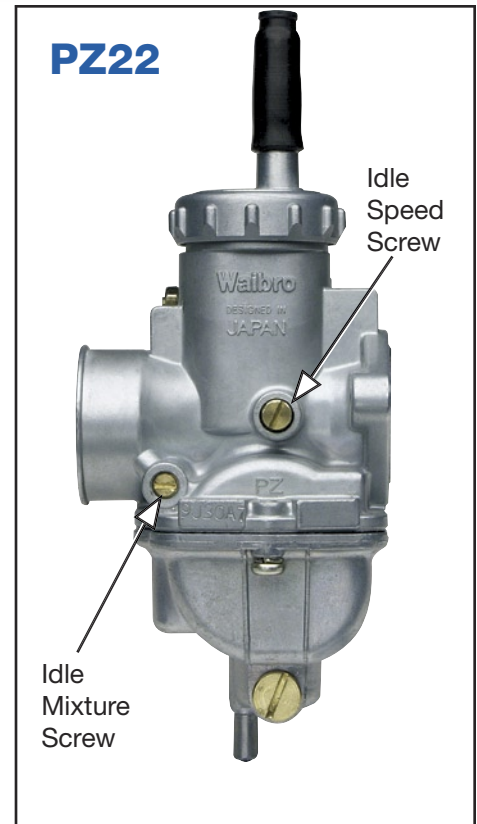

## Midrange/Part Throttle

Part involved:

- Jet Needle
- Main Nozzle (Needle Jet)
- Throttle Slide Valve

The Jet Needle primarily controls fuel flow between 10% and 75% throttle opening. The Jet Needle is the long narrow needle in the center of the throttle slide valve. The needle can be seen when the throttle is opened. It is held in place in the center of the throttle slide by a V-shaped clip.

The Jet Needle has five notches and a C-clip which determines the position of the needle in the slide based on which notch the clip is placed in. By varying the height of the needle in relation to throttle opening, the amount of taper of the needle in the main nozzle will change the fuel mixture.

To richen the part throttle operation, move the clip to the next lower notch. This will hold the needle farther out of the main nozzle and allow more fuel into the air stream. To lean part throttle operation move the clip to the next higher position. The notch at the top of the needle would be considered the first position (leanest). Needle taper reference letters are stamped on the needle for identification.

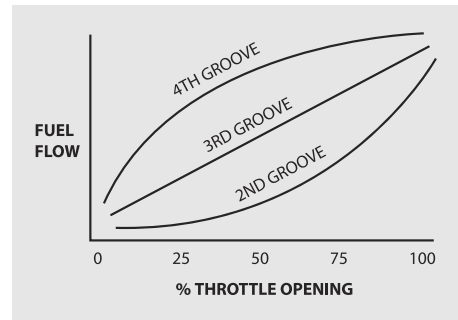

Location of C-clip on jet needle determines mid-range fuel mixture.



Be sure the V-shaped jet needle retaining clip is in place and will hold the jet needle securely in the slide.

RAISING THE NEEDLE IN THE SLIDE = RICHER MIXTURE  
 LOWERING THE NEEDLE IN THE SLIDE = LEANER MIXTURE

## High Speed/Full Throttle

Parts Involved:

- Main Jet

The Main Jet controls the fuel flow at throttle positions of one-half to full throttle. The Main Jet is located inside the float bowl and is screwed into the bottom of the Emulsion Tube in the center of the carburetor body. The jet size or diameter in millimeters is stamped on the jet. A larger diameter jet allows more fuel flow and a richer mixture.

Altitude and weather conditions can affect the engine operation enough to require changing the size of the Main Jet. High air temperature, humidity, or altitude could require a smaller Main Jet. Low temperature, humidity, or altitude would require a larger diameter Main Jet

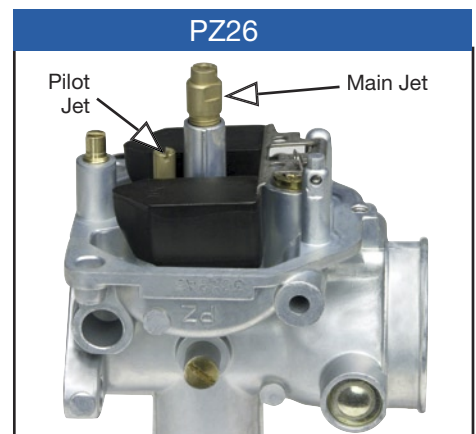
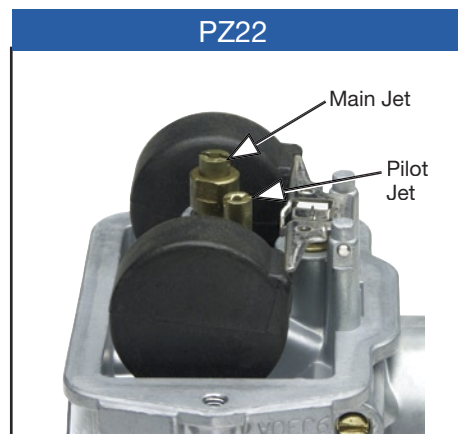

**RUNNING THE ENGINE WITH AN IMPROPER MAIN JET COULD RESULT IN A LOSS OF POWER, HIGH ENGINE TEMPERATURES, OR ENGINE DAMAGE.**

## TUNING TIPS

Gasoline is the typical fuel used for internal combustion engines. In some racing applications methanol alcohol is used for fuel. When using alcohol the engine must consume approximately twice as much fuel as with gasoline. For this reason some parts need to be replaced for proper tuning. The main nozzle, main and pilot jets, and the jet needle need to be replaced with the proper size.

If a carburetor has been working well and then develops a problem, the most likely cause is dirt or contamination in the carburetor. Dirt can plug jets or get stuck in the inlet needle and cause flooding. It will save time in the long run to be sure you are working with a clean carburetor.

If the engine performance seems to change or idle/low speed running

seems erratic, check for loose carburetor and manifold mounting bolts or leaking gaskets or seals. This can cause a vacuum leak and lean condition.

Symptoms of a rich mixture are:

- Black smoke or popping in the exhaust
- A “flat” running engine or dull sound
- Runs worse as engine warms

Symptoms of a lean mixture are:

- High cylinder head or exhaust temperature
- Backfire/popping from the carburetor
- Runs better with partial choke
- Surging or cutting out
- Pinging or rattling sound from engine under load

The Pilot Jet, Idle Mixture Screw and Jet Needle will have the most effect on acceleration from closed throttle.

A slightly rich idle mixture may help acceleration.

Moving the position of the Jet Needle clip is a good quick adjustment for a change in air temp. This will help with throttle response and corner exit.

The Main Jet will have the greatest effect at wide open throttle but will also affect mid-range operation. After a Main Jet change it may be necessary to move the Jet Needle position for best results.

The optimum float height setting may change from track to track. A rough track or an engine misfire in certain corners may require a float adjustment. If the carburetor can be rotated on the manifold, it may help to turn the carburetor a few degrees to compensate for a problem corner or for oval tracks.

## SET-UP

The throttle/pedal ratio is an item that can be tailored to suit the driver's style and benefit overall engine performance. By changing the distance from the pedal pivot to the point the throttle cable or linkage attaches to the pedal, the carburetor action can be slowed down to help throttle control on a slick or rough track or smooth out a choppy driver.

### IT IS IMPORTANT TO HAVE A FIXED STOP ON THE THROTTLE PEDAL.

This will reduce wear on the throttle cable and carburetor. Remove the air filter and visually confirm that the throttle slide reaches the wide open position just as the pedal hits the stop. The slide should also fully close with some slack in the cable with the pedal released. Idle speed cannot be set if the pedal is holding the slide partially open.

Seal the pedal end of the cable housing from dirt. Dirt will migrate up the throttle housing especially on a dirt track. Grit or debris on the slide

could cause sticking. A rubber cap can be used on the end of the cable housing with a small hole through it for the cable to slide through. A dab of silicone could also be used at the end of the cable housing. The cable housing should also be sealed by the rubber boot on the top of carburetor cap.

For the cable hook-up, remove the cover, spring and slide assembly. USE CAUTION while unscrewing the cover as it will have spring tension behind it. Make a note of the orientation of the slide valve. The small groove on

the side will align with a small guide pin in the bore. Thread the cable first thru the boot and cover, then thru the center of the spring and finally thru the top of the slide and hook the ball end under the bottom of the slide. (See photo.)

The hose attached to the bottom of the carburetor is for fuel overflow from the bowl. It should be routed down for proper draining.

Fuel pressure requirements are 1-3 psi.



## MAINTENANCE

### Draining carburetor

The carburetor should be “purged” of alcohol at the end of every day of running. Alcohol is very corrosive and will cause a lot of problems if left in the carb. The fuel line should be unhooked at the carburetor and the bowl drain screw opened to drain any fuel in the system. Another option is to run the engine on gasoline until it stalls. This will flush any alcohol out of the system. The carburetor should also be drained at least at the end of the season when running gasoline.

### Filters

Always use an inline fuel filter to prevent contamination inside the carburetor. Air filters should fit the carburetor properly and be kept clean.

### Bowl gasket

When reinstalling the float bowl you may find the gasket does not fit properly. If the gasket is too small it can be stretched to fit the groove. If it is wet it may swell slightly and can be set aside to dry and return to the proper size. If you are doing a lot of disassembly for tuning it may help to have extra gaskets.

### Cleaning/Inspection

Once a year the carburetor should be disassembled for cleaning and inspection. Look for wear on the jet needle and inlet tip. Inspect and/or replace o-rings and seals. If cleaning is necessary a toothpick will work for clearing any holes such as jets. Remove the Inlet Needle and use a

Q-tip to clean the inside of the inlet seat. Compressed air is also useful to remove contamination. The pilot jet has a very small metering orifice. If it cannot be blown out it will likely need to be replaced.

Always use a stop on the gas pedal. This reduces wear on the carburetor and the chance of a stuck throttle.

## SPECIFICATIONS

### PZ26A63

Main Jet: 96  
Pilot Jet: 38  
Main Nozzle Diameter: 2.6  
Jet Needle: CDB/3<sup>rd</sup> notch  
Mixture Screw: 1 turn  
Float Height: 14mm (.550in)

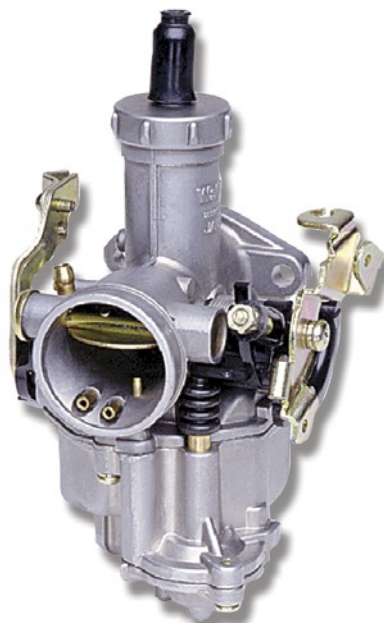

### PZ22A15

Main Jet: 95  
Pilot Jet: 32  
Main Nozzle Diameter: 2.6  
Jet Needle: BGB/2<sup>nd</sup> notch  
Mixture Screw: 1 ½ turn  
Float Height: 22.0mm (.860in)

